



SHRINKING TECHNOLOGY

Induction shrinking stations and accessories

 **pokolm**
PREMIUMTOOLS. WE KNOW HOW.

INDUCTION SHRINKING TECHNOLOGY - COST-EFFECTIVE AND INNOVATIVE FOR THE HIGHEST REQUIREMENTS

The shrinking technology convinces with its advantages as compared to the conventional chucking methods of many users. Above all, that includes the extremely high concentricity, which simultaneously guarantees the highest precision as well as long tool lives. In addition, the shrinking technology creates an ideal, friction-locked connection between the tool and arbor and thus guarantees a high transferable torque. The suitability for maximum speed is moreover the best prerequisite for achieving an ideal surface grade thereby avoiding expensive ultrafine machining processes.

As compared to conventional tool arbors, shrinking arbors have a slimmer design so they facilitate the use of the smallest tools even at great depths - something that cannot be realised with a hydraulic expansion chuck.

At POKOLM, the customer obtains an extensive and perfectly matched range for shrinking technology from one single source:

- ➔ High quality, mature induction shrinking units with extensive accessories that satisfy every demand placed on comfort and profitability
- ➔ Shrinking arbors for all common machine connections
- ➔ The **DUOPLUG®** connection system patented by POKOLM provides the greatest concentricity and maximum rigidity
- ➔ Milling cutter bodies with **DUOPLUG®** connection
- ➔ Solid carbide end mills for every application

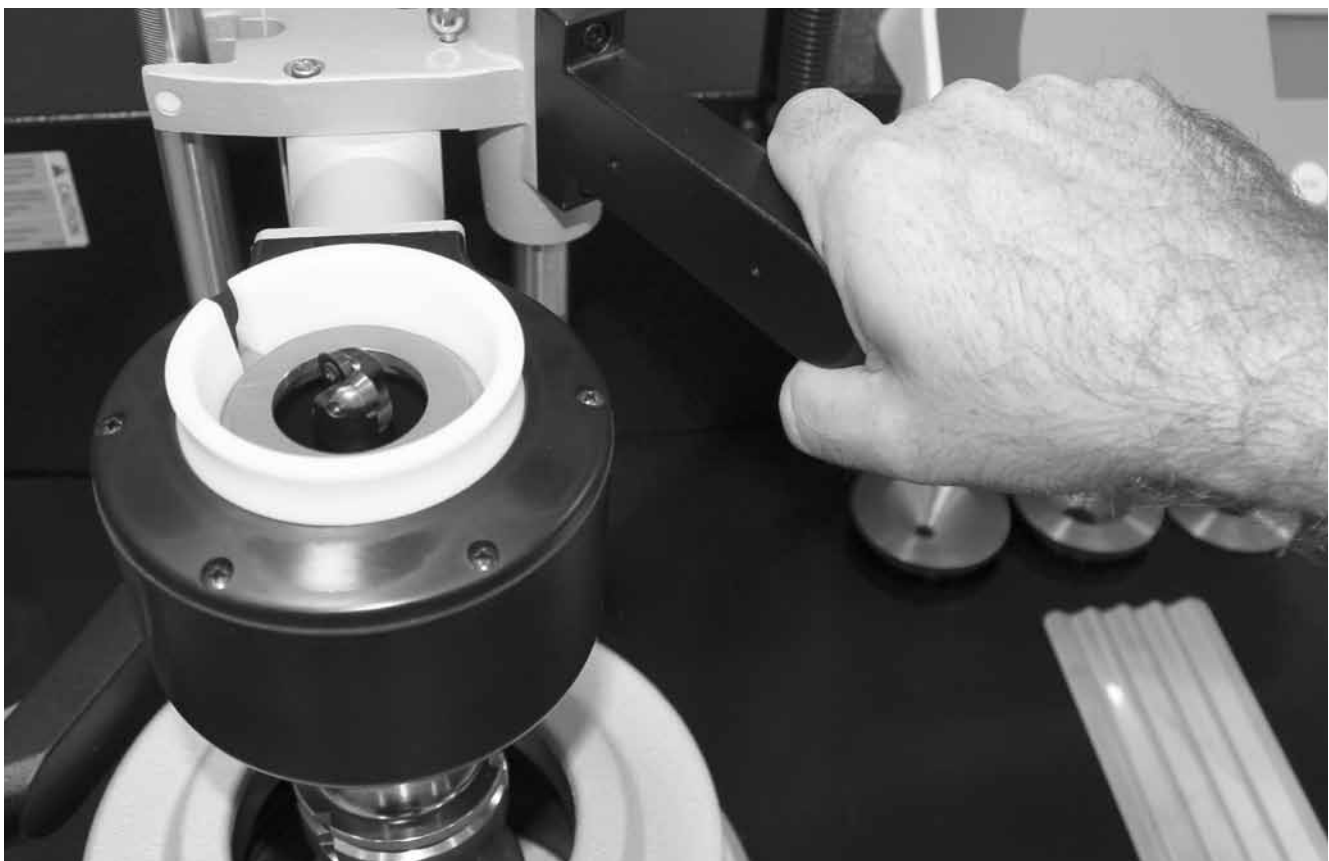

AN EXTENSIVE AND INTEGRATED RANGE

Content	Page
<p>➔ Induction shrinking stations TSI11000WKT / TSI11000WKS innovative comfort packages with integrated cooling equipment</p> <ul style="list-style-type: none"> - Description 4 - Semiautomatic table top device TSI11000WKT, fully automatic comfort device TSI11000WKS 5 - Operation display, technical data 6 - Accessories 7 	
<p>➔ Induction shrinking unit TSI3510 The classic as an especially economical solution</p> <ul style="list-style-type: none"> - Description 8 - Operator's controls, technical data 9 - Accessories 10 	
<p>➔ Arbors and adapters</p>	11

Diversity in the highest quality

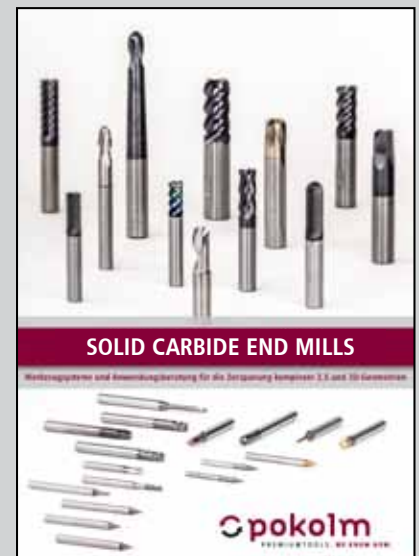
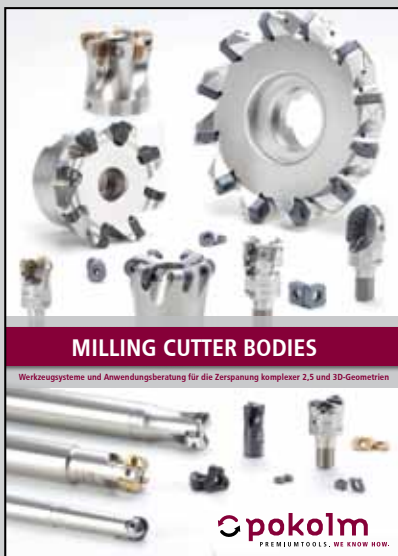

The intelligent POKOLM tool system is composed of milling cutter bodies, arbors and adapters and solid carbide end mills together with induction shrinking units.

Through our own development and manufacturing, all products are perfectly matched to each other and can be compiled into more than 500,000 useful options. That makes the POKOLM product range the best possible combination for any application.

INDUCTION SHRINKING STATIONS TSI11000WKT /-WKS

HIGH-PERFORMANCE, SAFE, EASY-TO-USE DEVICE

The semiautomatic induction shrinking station TSI11000WKT and its fully automatic equivalent TSI11000WKS provide the user 11 kW powerful, easy-to-use devices that boast the latest type of construction. Both have high capacity design margins and a great number of innovative attributes.

For instance, the semi-automatic shrinking and fluid-supported cooling process is run in a single position in the unit.

A ferrite disc system prevents the tool from heating up and facilitates problem-free clamping of solid carbide end mills and rods as well as heavy metal extensions - the hot spot is pushed into the ideal area.

Equipped with automatic water cooling, the shrinking arbor in the unit is always cooled to room temperature. Overheating and risk of burns along with damage to the tool edge are made impossible. Setup times are reduced to a minimum.

The operating concept is especially user friendly.

Comprehensive protection systems prevent damage to the arbor or the unit on top of that.

Advantages at a glance

- ⊕ High-performance, easy-to-use devices
- ⊕ Even shorter shrinking times
- ⊕ Targeted heating
- ⊕ Minimised danger of burns
- ⊕ Shortened setup times
- ⊕ Simple operation
- ⊕ Integrated water cooling
- ⊕ preinstalled parameters for POKOLM arbors
- ⊕ own shrinking programmes can be saved
- ⊕ fast data exchange via PC using the optional available accessory set (TSI11000WK-ZB-TME)
- ⊕ perfect for the **DUOPLUG®** system for ultimate truth of running and maximum rigidity



Water cooling system

The all-in-one solution permits the shrinking and cooling process in one position. There is no contact with the hot chuck. That excludes a danger of burns and saves time.

Scope of delivery

Induction shrinking station TSI11000WKT-Set/ ...WKS-Set

Adapter, water cooled

The scope of delivery includes an adapter.

Please state the desired item no. in your order.
(See selection on page 7)

Ferrite discs, complete set including 4 units

3.0 - 5.9 mm; 6.0 - 12 mm; 12.1 - 22 mm; 22.1 - 32 mm

Cooling emulsion, 1l bottle, concentrate for one filling

Clamping ring, 1 unit

Protective gloves, 1 pair

Allen key, 5 mm

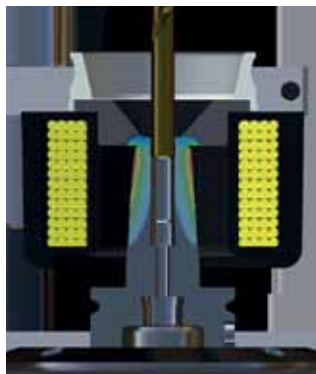

Ferrite disc changer system

Reduces tool heat-up. The hot spot is pushed into the ideal area. Adapting the magnetic alternating field increases the efficiency.

INDUCTION SHRINKING STATIONS TSI11000WKT /-WKS DIFFERENCES AND DETAILS

TSI11000WKT - semiautomatic table top device in detail

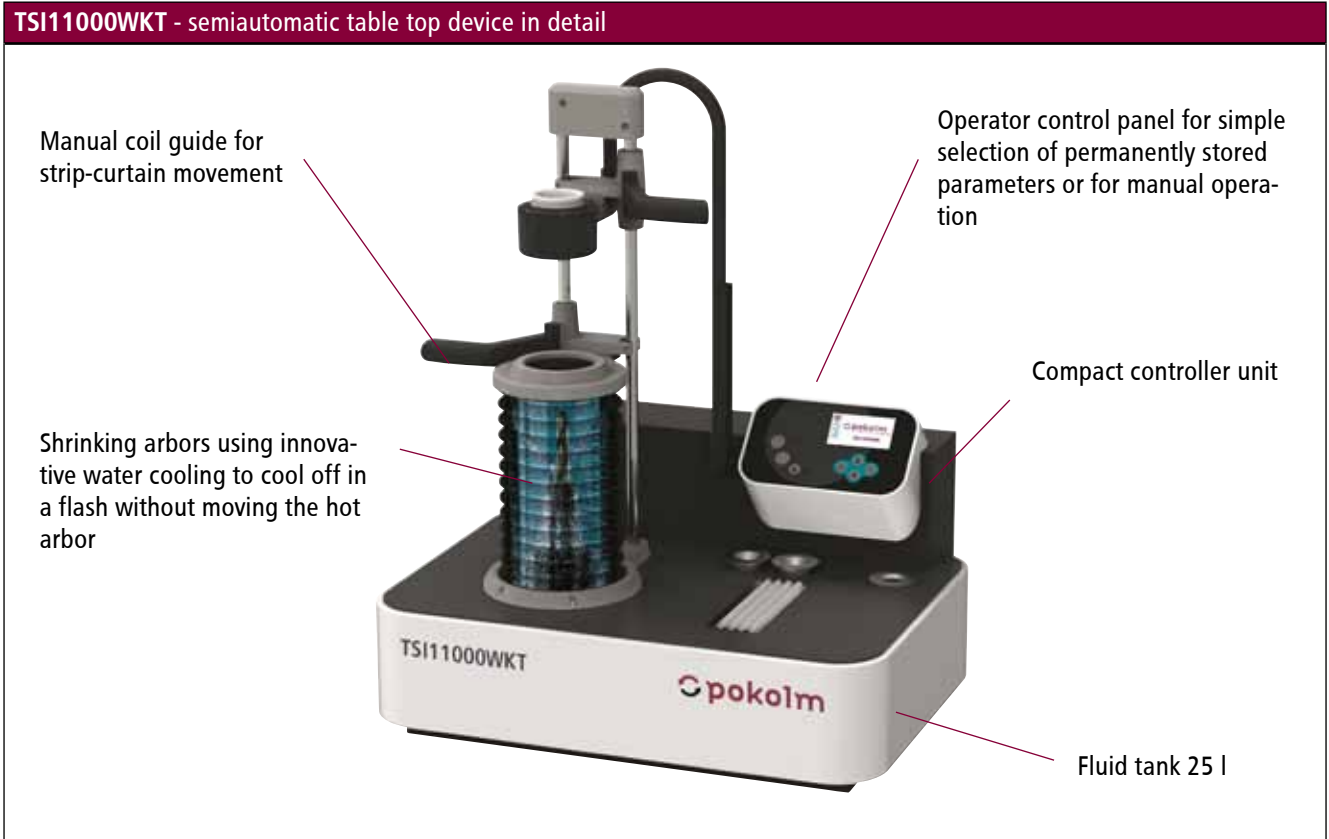

TSI11000WKS - fully automatic comfort device in detail

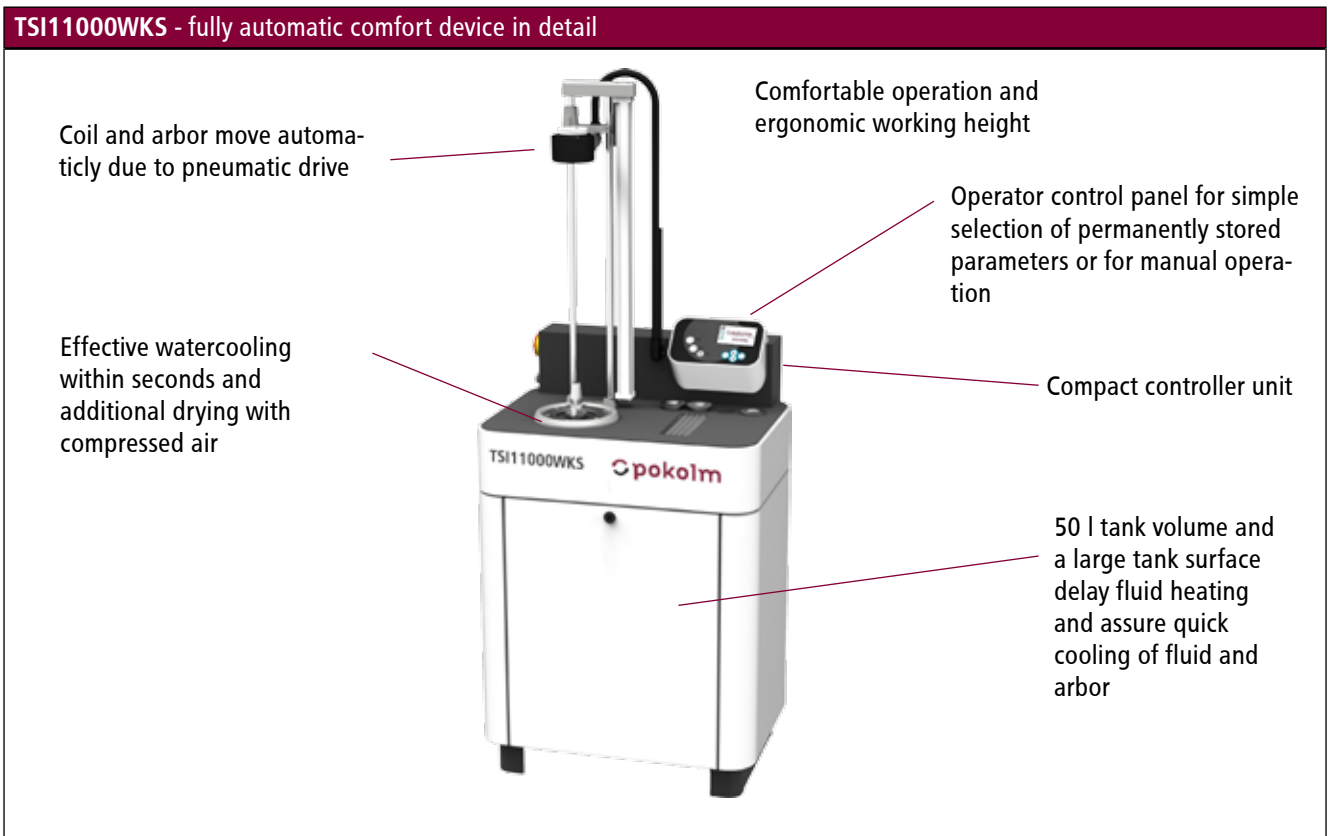

INDUCTION SHRINKING STATIONS TSI11000WKT /-WKS

OPERATION DISPLAY, TECHNICAL DATA

Comfortable operation display



- ⊕ Colour display
- ⊕ Easy selection by pictograms
- ⊕ intuitive machine operation
- ⊕ language independent

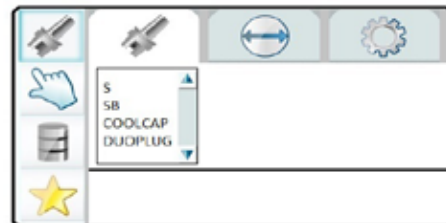

- ⊕ Selection of shrinking mode with preinstalled arbor parameters

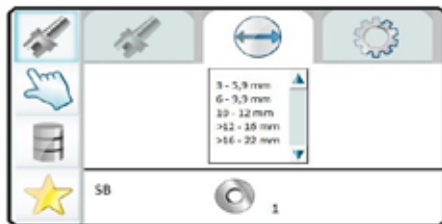

- ⊕ Selection of shrinking diameter



- ⊕ Displaying parameter, processing status and required ferrite disc

Technical data

	TSI11000WKT	TSI11000WKS
Name	TSI11000WKT	TSI11000WKS
Output	11 kW	
System voltage	400 V, 50 Hz, 16 A	
Cooling	Fluid cooling	
Compressed air	-	4 bar (dried, nonlubricated, filtered)
Max. machine interface	HSK25 - HSK100, SK/BT30 - SK/BT50	
Contour-independent cooling	Yes	
Cooling time	~ 20 - 40 s	
Fluid tank	~ 25 l	~ 50 l
Dimensions	W 800, D 560, H 1130 mm	W 800, D 560, H 1720 mm
Clamping range Solid Carbide	Ø 3 - 32 mm	
Coil	fixed, Ø 54 mm	
Max. tool length	400 mm in the HSK63	
Max. cooling length	160 mm in the HSK63	
Weight	~ 70 kg	~ 120 kg

On request, the induction shrinking station TSI11000WKS is also available in a version with a replaceable exchange-coil for large clamping diameters up to 50 mm.

INDUCTION SHRINKING STATIONS TSI11000WKT /-WKS

ACCESSORIES

Accessories and spare parts		Item no.	
	Adapter, water cooled for correct positioning of the arbor in the shrinking unit including a rotation lock for DUOPLUG®	HSK 25	TSI11000WK-AD-HSK25
		HSK 32	TSI11000WK-AD-HSK32
		HSK 40	TSI11000WK-AD-HSK40
		HSK 50	TSI11000WK-AD-HSK50
		HSK 63	TSI11000WK-AD-HSK63
		HSK 80	TSI11000WK-AD-HSK80
		HSK 100	TSI11000WK-AD-HSK100
		SK 30 / BT 30	TSI11000WK-AD-SK30-BT30
		SK 40 / BT 40	TSI11000WK-AD-SK40-BT40
SK 50 / BT 50	TSI11000WK-AD-SK50-BT50		
	Ferrite discs, for "SB arbors" and DUOPLUG® , for perfect magnetic field shielding between the coil and the tool shank	Clamp-Ø 3.0 - 5.9 mm	TSI11000WK-ZB-FSN-0
		Clamp-Ø 6.0 - 12.0 mm	TSI11000WK-ZB-FSN-1
		Clamp-Ø 12.1 - 22.0 mm	TSI11000WK-ZB-FSN-2
		Clamp-Ø 22.1 - 32.0 mm	TSI11000WK-ZB-FSN-3
	Ferrite discs, for slim "S-arbors" and COOLCAP® for perfect magnetic field shielding between the coil and the tool shank	Clamp-Ø 3 mm	TSI11000WK-ZB-FSS-03
		Clamp-Ø 4 mm	TSI11000WK-ZB-FSS-04
		Clamp-Ø 5 mm	TSI11000WK-ZB-FSS-05
		Clamp-Ø 6 mm	TSI11000WK-ZB-FSS-06
		Clamp-Ø 8 mm	TSI11000WK-ZB-FSS-08
		Clamp-Ø 10 mm	TSI11000WK-ZB-FSS-10
		Clamp-Ø 12 mm	TSI11000WK-ZB-FSS-12
		Clamp-Ø 14 mm	TSI11000WK-ZB-FSS-14
		Clamp-Ø 16 mm	TSI11000WK-ZB-FSS-16
		Clamp-Ø 18 mm	TSI11000WK-ZB-FSS-18
		Clamp-Ø 20 mm	TSI11000WK-ZB-FSS-20
		Clamp-Ø 25 mm	TSI11000WK-ZB-FSS-25
			Ferrite discs for slim „S-arbors“, a complete set in a practical storage case
	Ferrite discs, separated , for use if cutting diameter is bigger than shrinking diameter	Clamp-Ø 3.0 - 5.9 mm	TSI11000WK-ZB-FSG-0
		Clamp-Ø 6.0 - 12.0 mm	TSI11000WK-ZB-FSG-1
		Clamp-Ø 12.1 - 22.0 mm	TSI11000WK-ZB-FSG-2
		Clamp-Ø 22.1 - 32.0 mm	TSI11000WK-ZB-FSG-3
	Stop block , for coil positioning during special applications		TSI11000WK-ZB-A
	Clamp ring , for securely fixation the ferrite disc on the coil		TSI11000WK-ZB-KR
	Cooling emulsion , for protecting the chuck from corrosion	1l bottle	TSI11000WK-ZB-KE-1L
	Machine and system cleaner	5l canister	TSI11000WK-ZB-R
	Cooling plate , to store hot tools	Made of steel, with foot	TSI11000WK-ZB-KB
	Document store , for installation above display	for DIN A4	TSI11000WK-ZB-DA

INDUCTION SHRINKING UNIT TSI3510 - ECONOMICAL ENTRY INTO SHRINKING TECHNOLOGY

The induction shrinking unit TSI3510 provides the user with a 3.5 kW powerful basic unit that sets itself apart with a great number of proven attributes.

The most important: short setup times. That reduces setup and conversion costs! At the same time, the arbor is heated quickly and uniformly with induction technology while the tool itself is heated up only to the minimum. The TSI3510 stands for precision and safety.

A removable hand-held unit enables flexible shrink fitting and removal of the shrunk component even directly on the machine or in the vice. An attribute that ensures time saving during conversions.

The TSI3510 does not require any installation work at all. The simple ergonomic operation, the integrated air cooling and the reliable power output of the unit create additional important deciding factors as a „low cost entry“ in induction shrinking technology.



Advantages at a glance

- ➔ Basic unit
- ➔ Simple operation
- ➔ Removable hand part
- ➔ Integrated air cooling

Scope of delivery

Induction shrinking unit TSI3510-Set

Adapter ring

The scope of delivery includes an adapter ring.
Please state the desired item no. in your order.
(See selection on page 10)

Accessories set for TSI3510
(TSI3510-ZB-SET)

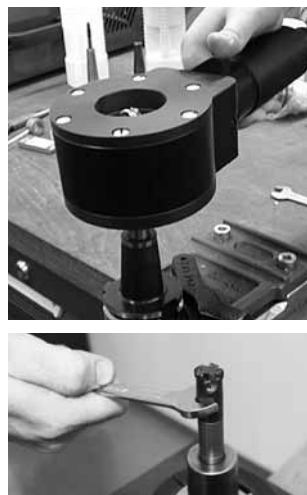

Also practical for
DUOPLUG®

The patented POKOLM **DUOPLUG®** screw-shrink connection can even be easily shrink-fit and removed with the detachable induction coil.



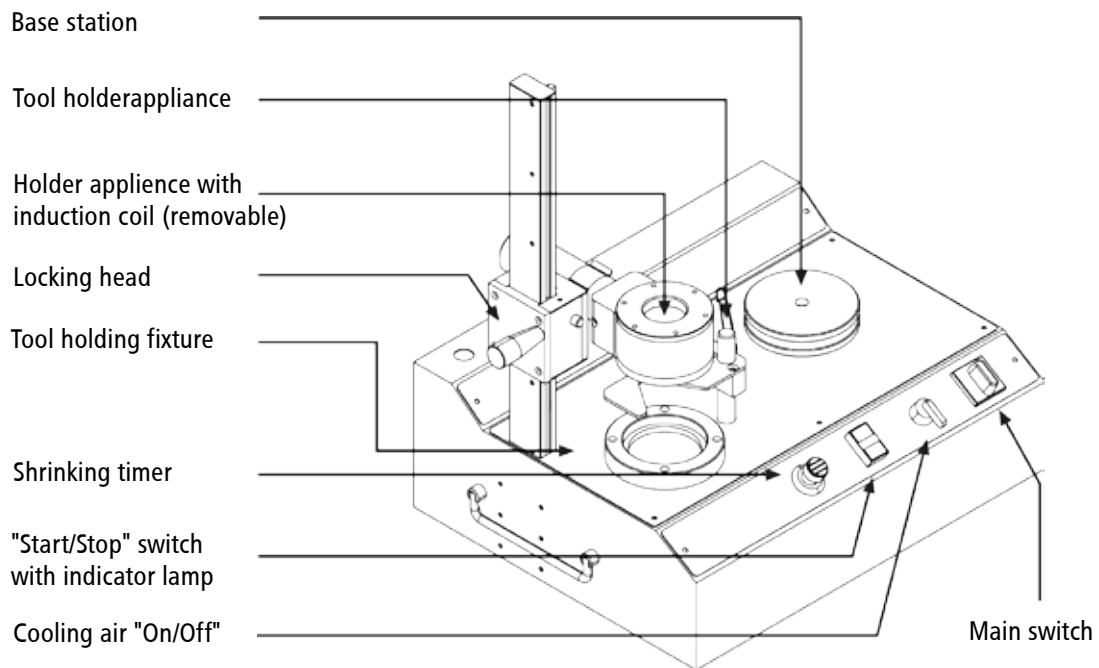

INDUCTION SHRINKING UNIT TSI3510 - OPERATOR'S CONTROLS, TECHNICAL DATA

Operating elements



Name	TSI3510
Output	3.5 kW
System voltage	230 V, 50 Hz, 16 A
Cooling	Air cooling
Clamping range Solid Carbide	Ø 6 - 25 mm
Coil diameter	48 mm
Max. operating time	Variably adjustable up to 30 sec.
Dimensions (without linear unit)	L 555, W 450, H 200 mm
Weight	~ 30 kg

INDUCTION SHRINKING UNIT TSI3510 - ACCESSORIES





Accessories and spare parts		Item no.	
	Spacer rings for adjusting the desired shrink-in length, with a set-screw for fastening	Ø 03 mm	RING 3 MADS
		Ø 04 mm	RING 4 MADS
		Ø 06 mm	RING 6 MADS
		Ø 08 mm	RING 8 MADS
		Ø 10 mm	RING 10 MADS
		Ø 12 mm	RING 12 MADS
		Ø 16 mm	RING 16 MADS
		Ø 20 mm	RING 20 MADS
	Adapter rings for centring all conventional arbor systems and sizes in the unit	HSK 32	RING HSK 32
		HSK 40	RING HSK 40
		HSK 50	RING HSK 50
		HSK 63	RING HSK 63
		HSK 80	RING HSK 80
		SK 30	RING SK 30
		SK 40	RING SK 40
		SK 50 / HSK 100	RING SK 50
	Pliers for safe insertion and removal of the cutter into or out of the arbor	Angled 45°	ZANGE
	Accessories set for TSI3510	Contents: - Spacer rings 06 - 20 mm - Holder for adjustment rings - Adapter ring SK 50 / HSK 100 - Pliers - Allen key 2.5 x 100 mm - Revolver holder for storing up to 20 cutters with various diameters - Protective gloves, size 10	TSI3510-ZB-SET
	Protective gloves, made of Kevlar fabric	Universal size 10	H-SCHUTZ

ARBORS AND ADAPTERS FROM POKOLM PERFECT FOR SHRINKING TECHNOLOGY

Milling tools or arbors and adapters - they are all manufactured according to the highest standards. Only then can they live up to the premium requirements for which the POKOLM products are famous. Accordingly, our shrinking arbors are fabricated with extreme precision and are characterised by perfect concentricity. With our own product development, design and precision manufacturing, we are able to perfectly adapt our arbors to your shrinking units down to the last detail. POKOLM shrinking arbors and shrinking units create the best-possible combination. Our shrinking arbors are available for shank diameters from 3 - 32 mm and naturally are ideal for all conventional machine connections. Fine length graduations ensure perfect stability even under difficult application conditions.



Arbors and adapters for shrinking at a glance

With steep taper shank	With hollow taper shank	With Morse taper shank	Adapters and extensions
			
SK 30	HSK 25	CM 3	Shrinking extensions
SK 40	HSK 32	CM 4	Extension shrinking adapter
SK 50	HSK 40	CM 5	
BT 30	HSK 50		
BT 40	HSK 63		
BT 50	HSK 100		
Designs: SK: DIN 69871 AD BT: JIS B6339 AD	Designs: Form E, Form EC, Form A DIN 69893	Design: DIN 228 A	



You can find the complete range of the listed shrinking arbors with all the detailed technical information in our comprehensive catalogue on arbor systems or, alternatively, on our website at www.pokolm.de/en/aufnahmesysteme.

Alternatively, simply use the adjacent QR-code linked to this website.



We would also be glad to send you the printed edition of the catalogue. Just ask for it! By telephone at +49 5247 9361-0 or send an email to info@pokolm.de

